

JM-1450™ Electric Jet Operating Instructions

For 2" to 4" lines up to 150 ft. long



Your JM-1450 Jet-Set electric water jet is designed to give you years of trouble-free, profitable service. However, no machine is better than its operator.

Read, understand and follow all safety warnings and instructions provided with the product. Failure to follow the warnings and instructions may result in electric shock and/or serious injury. Save all warnings and instructions for future reference.

SAVE THESE INSTRUCTIONS!

Pour français voir la page 11

Para ver el español vea la página 21

***General
PIPE CLEANERS***



! WARNING

Read and understand operator's manual before using this machine. Failure to follow operating instructions could result in death or serious injury.

WARNING! Read and understand all instructions. Failure to follow all instructions listed below may result in electric shock, fire and/or serious personal injury. Replacement manuals are available upon request at no charge, or may be downloaded from our website, www.drainbrain.com. Instructional videos are available for download on our website, and may be ordered. If you have any questions or problems, please call General's customer service department at 412-771-6300.

SAVE THESE INSTRUCTIONS!

These instructions are intended to familiarize all personnel with the safe operation and maintenance procedures for the JM-1450.

SAFETY SYMBOLS



This is the safety alert symbol. It is used to alert you to potential personal injury hazards. Obey all safety messages that follow this symbol to avoid possible injury or death.

! DANGER

DANGER indicates a hazard with a high level of risk which, if not avoided, will result in death or serious injury.

! WARNING

WARNING indicates a hazard with a medium level of risk which, if not avoided, could result in death or serious injury.

! CAUTION

CAUTION indicates a hazard with a low level of risk which, if not avoided, will result in minor or moderate injury.

! WARNING



Electric shock resulting in death can occur if you plug this machine into an improperly wired outlet. If the ground wire is electrified, you can be electrocuted by just touching the machine, even when the power switch is off. A ground fault circuit interrupter will not protect you in this situation. Use a UL approved tester to determine if the outlet is safe.



Do not operate power tools in explosive atmospheres, such as in the presence of flammable liquids, gases, or dust. Power tools create sparks which may ignite the dust or fumes.

Do not spray flammable liquids. Risk of explosion. Flammable liquids can create fumes which can ignite causing property damage or severe injury.

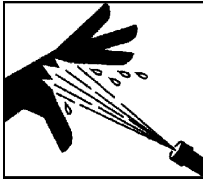

Do not direct discharge stream at people. This equipment can produce a high pressure stream of fluid that can pierce skin and its underlying tissues, leading to serious injury and possible amputation or death.



Always wear safety glasses and rubber soled, non-slip shoes. High pressure spray can cause paint chips or other particles to become airborne and fly at high speeds. Use of this safety equipment may prevent serious injury.

! WARNING

This product can expose you to chemicals including lead, which is known to the State of California to cause cancer and birth defects or other reproductive harm. For more information go to www.P65Warnings.ca.gov.

GENERAL SAFETY RULES



WARNING

Read and understand all instructions. Failure to follow all instructions listed below may result in electric shock, fire, and/or serious injury.

SAVE THESE INSTRUCTIONS!

WORK AREA SAFETY

1. **All installations must comply with local codes.** Contact your electrician, plumber, utility company or the selling distributor for specific details. To comply with the National Electrical code (NFPA 70) and provide additional protection from risk of electric shock, the machines are equipped with a UL approved ground fault circuit interrupter (GFCI) power cord.
2. **Risk of explosion. Do not spray flammable liquids or operate in an area where flammable or explosive materials are used or stored.** Power tools create sparks which may ignite dust and fumes.
3. **Keep bystanders, children, and visitors away while operating machine.** Distractions can cause you to lose control.

ELECTRICAL SAFETY

1. **Grounded tools must be plugged into an outlet, properly installed and grounded in accordance with all codes and ordinances. Never remove the grounding prong or modify the plug in any way. Do not use any adapter plugs. Check with a qualified electrician if you are in doubt as to whether the outlet is properly grounded.** If the tool should electrically malfunction or break down, grounding provides a low resistance path to carry electricity away from the user.
2. **Avoid body contact with grounded surfaces such as pipes, radiators, ranges and refrigerators.** There is an increased risk of electric shock if your body is grounded.
3. **Do not expose power tools to rain or wet conditions.** Water entering a power tool will increase the risk of electric shock.
4. **When operating a power tool outside use an outdoor extension cord marked "W-A" or "W".** These cords are rated for outdoor use and reduce the risk of electric shock.
5. **Test the Ground Fault Circuit Interrupter (GFCI) provided with the power cord to insure it is operating correctly before operating machine.** Machine must have a properly functioning ground fault circuit interrupter on the power cord. GFCI reduces the risk of electric shock.
6. **Extension cords are not recommended unless they are plugged into a Ground Fault Circuit Interrupter (GFCI) found in circuit boxes or outlet receptacles.** The GFCI on the machine power cord will not prevent electric shock from the extension cords.
7. **Only use proper three-wire extension cords in good condition of no more than 50 ft. in length which have three-prong grounding plugs and three-pole receptacles which accept the tools plug.** Use of damaged, inferior, or other extension cords will not ground the tool, increases the risk of damage to the machine, electric shock, bodily injury or death.
8. **Keep all electric connections dry and off the ground.** Reduces the risk of electric shock.

9. **DO NOT touch plugs or tools with wet hands.** Reduces the risk of electric shock.

GROUND FAULT CIRCUIT INTERRUPTER (GFCI)

Your machine is equipped with a ground fault circuit interrupter, which protects you against shock if a short circuit should occur. Check that receptacle is properly grounded. Test the GFCI before each use.

1. Plug into 120-volt receptacle.
2. Push test button. Indicator light will go out and power to machine should cut off.
3. If light does not go out when test button is pushed, **DO NOT USE THE MACHINE** until proper repairs can be made.
4. To restore power after test, push reset button. With the reset button depressed, if the machine doesn't start, stops while running, or if the operator experiences a mild shock, **DO NOT USE THE MACHINE!** Tag the machine out of service and take it to a motor repair center or return it to the factory for repairs.

PERSONAL SAFETY

1. **High pressure developed by jet machines will cause personal injury. Water spray should not be pointed at any person.** High pressure spray can result in serious injury. If fluid seems to have penetrated the skin, seek emergency medical attention at once.
2. **Grip jet hose or spray wand securely with both hands before starting the machine.** Failure to do so could result in injury from a whipping hose or wand.
3. **Always wear eye protection and rubber gloves.** Safety equipment, eye safety devices, non-skid safety shoes and protective clothing must be worn when using this equipment.
4. **Stay alert, watch what you are doing and use common sense when operating a power tool. Do not use tool while tired or under the influence of drugs, alcohol, or medication.** A moment of inattention while operating power tools may result in serious personal injury.
5. **Dress properly. Do not wear loose clothing or jewelry. Contain long hair. Keep your hair, clothing, and gloves away from moving parts.** Loose clothes, jewelry, or long hair can be caught in moving parts.

SERVICE

1. **Tool service must only be performed by qualified service personnel.** Service or maintenance performed by untrained personnel could result in injury and damage to the equipment.
2. **When servicing tool, use only identical replacement parts. Follow instructions in maintenance section of this manual.** Use of unauthorized parts or failure to follow maintenance instructions may cause injury or damage to equipment.

JET SAFETY

1. **Do not operate jet above rate pressure or above 140 degrees (rated water temperature).** Operating jet above rate specifications risks damage to the pump and related components, and will void the warranty.
2. **Do not operate jet with the output valve in the off position for extensive periods of time.** This will cause the water to overheat and damage the pump.
3. **Never run pump without water in it.** Operating the machine without water will cause the pump to fail and void the warranty.

4. Check for worn hose and components before each use. Check that all fittings are secured before using jet. Worn or loose fittings can cause damage to the machine and injure the operator.
5. Protect machine and pump from freezing. Storing or operating the jet in temperatures below freezing can damage pump, hose and other jet components. Store unit indoors or protect with anti-freeze when not in use.
6. General Wire Spring Co. will not be liable for any changes made to our standard machines or any components not purchased from General Wire Spring Co.

JM-1450 SPECIFICATIONS

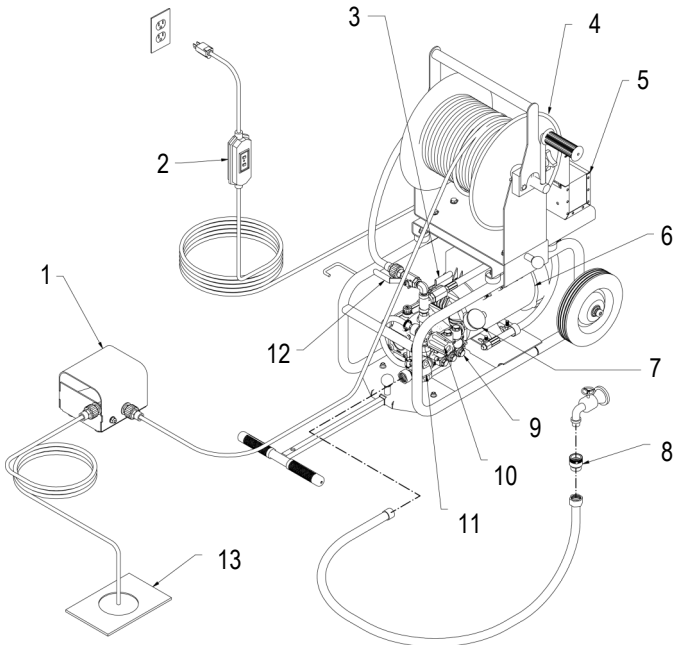

- | | |
|------------------------------|----------------------------|
| 1. Foot Pedal (optional) | 8. Anti-Siphon Valve |
| 2. GFCI | 9. Pump |
| 3. Vibra-Pulse Control Valve | 10. Unloader |
| 4. Hose Reel | 11. Inlet Filter |
| 5. Tool Box | 12. Pressure Control Valve |
| 6. Motor | 13. Drain |
| 7. Pressure Gauge | |

REMOVABLE HOSE REEL

The JM-1450 features a removable hose reel. It easily detaches in seconds to make the machine more compact to fit in small spaces in your truck, or crawl spaces under a building, or to more easily carry the machine up to a roof to clear lines via the roof vents. To remove reel, unscrew twist connect at the output valve, then simply pull the knob at the base of the hose reel, then lift the reel. To reattach reel, align the slot in the base of the reel with the tab on the support bracket. Then seat reel into bracket and allow the knob to snap back into place.



SLIDE OUT HANDLE

A convenient slide-out handle makes the JM-1450 really portable. Lift the knob and extend the handle, then roll the machine to and from the job on the 8" wheels. Lift the knob to slide the handle back into place.



JET HOSE

1. When selecting hose size, consider that pressure is lost as the water travels down the length of the hose. As the length increases, the pressure decreases. In addition, the smaller the diameter of the hose, the greater the loss of pressure per foot will be. As an example, a 2 GPM a 1/4" hose will lose 180 lbs. of pressure over 100 ft. of hose, yet a 3/8" hose will only lose 25 lbs. of pressure over the same length and at the same flow rate. At 4 GPM, a 3/8" hose will lose 90 lbs. of pressure over a 100 ft. length. The gauge reflects pressure from the pump only, not pressure at the end of the hose. It is important to select the largest possible hose size in order to have as much pressure as possible at the end of the hose.
2. Hoses of the same diameter may be coupled together using the CC-1 coupling, but it is not recommended for use in lines smaller than 8" in diameter. The long length of the hose connectors and coupling together can get caught in bends in the line. It is not advisable to have two different hose sizes coupled in a drain line. There is a tremendous loss of pressure when combined, aside from the difficulty of getting around bends.
3. The 3/8" and 1/4" hoses may be attached to the fitting in the core of the hose reel using the swivel at one end of the hose. The 1/8" accessory hose may also be attached directly to the output valve by using the twist connect supplied on the hose.

HOSE SELECTION GUIDE

Hose Size (ID*)	Pipe Size	Typical Applications
1/8" (3.175mm)	1-1/2" - 2" (38mm - 51mm)	Small lines, bathroom sinks, tight bends
1/4" (6.350mm)	2" - 4" (51mm - 102mm)	Kitchen sinks, laundry drains, clean outs
3/8" (9.925mm)	4" - 8" (102mm - 230mm)	Floor drains, septic lines, long runs

* Inside Diameter

JET NOZZLES

1. A variety of jet nozzles are available for drain cleaning. Each has a different spray pattern and purpose. Some nozzles may have an orifice in the front to cut through the stoppage. All will have holes in the back to drive the hose down the line and clean the walls of the pipe. A tight spray pattern (15°) has more driving power for long runs, a wide spray pattern (40°) does a better job of cutting the grease off of the walls of the pipe. A combination of nozzles may be required to clear a line. Always turn off the machine and turn off output valve before changing nozzles.

2. Make sure the nozzle you are using matches the pump size. A 3000 psi pump requires a different nozzle orifice than a 1500 psi pump. Mismatching nozzles with pump size will either cause too little pressure, which may not clear the drain, or too much pressure, which may damage the machine.
3. Check nozzles before and after each use for clogged holes which can cause pressure to increase to dangerously high levels and damage the pump. A clogged hole can be cleared by simply using the NCT Nozzle Cleaning Tool.
4. Use the nozzle selection guide to determine what nozzle you will need for various applications. Examples: If a nozzle is stamped #12, it is a JN-12, drilled for 1.7 GPM @ 1500 PSI with several 15° rear jets and one forward cutting jet.

Powerful penetrating nozzle cuts through grease and ice.

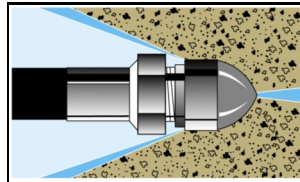

Wide spray flushing nozzle cleans inside of pipe thoroughly.

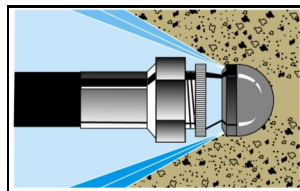

SPECIALTY NOZZLES

Spring leader nozzles and down head nozzles are special nozzles to help hose travel through the pipe when there are a lot of Tee's, curves, and bends.

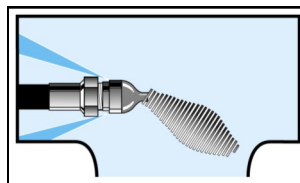
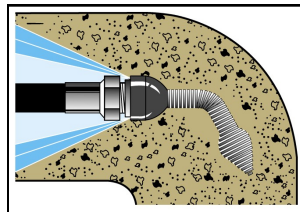

ROTARY NOZZLES

Rotary nozzles are useful as a finishing tool. After the line has been cleared, you may switch to the rotary nozzle to more thoroughly clean the walls of the pipe. Use these nozzles only in a predominantly straight run since they are longer than regular nozzles and may get caught in tight bends.

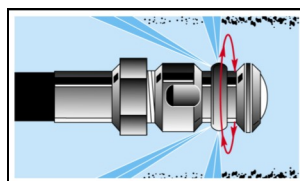

NOZZLE SELECTION GUIDE

HOSE SIZE	1/8"	1/4"	3/8"
	CAT #	CAT #	CAT #
15° Rear Jets w/No Forward Jet	JN-1	JN-11	JN-21
15° Rear Jets w/One Forward Jet	JN-2	JN-12	JN-22
30° Rear Jets w/No Forward Jet	JN-3	-	-
40° Rear Jets w/No Forward Jet	-	JN-14	JN-24
Spring Leader	JNSL-1	JNSL-2	JNSL-3
Down Head Nozzle	JNDH-1	-	-
Rotary Nozzle* (Optional)	-	JNRA-2 JNRB-2	-

* Rotary Nozzles can be adapted to 1/8" and 3/8" hose using AD-3 or AD-4 adapters.

JET ASSEMBLY

- Upon arrival, inspect the shipping crate for damages. Uncrate and examine all parts. Note any damage to machine or components for claims against freight carrier.
- Jet must be stored and operated in horizontal position. Never store in upright position or oil may leak from pump. If low, fill with SAE 30 weight non-detergent oil.
- Jet machines are meant to be used at or near the working area and under operator supervision. If machine must be located out of sight of operator, special controls may be required for proper machine operation and operator safety

OPERATION

SET-UP

1. Locate the jet near the drain line on a level surface with drainage.

Tip: Ideally, the drain line should be cleared from the downstream side, that is, from the street back toward the house. If you must clear the line from the drain toward the street, you may need to use a siphon pump to clear away excess water.
2. Check the oil level in the pump. If low, fill with SAE 30 weight non-detergent oil.
3. Check the inlet filter to make sure it's clean before each use. To clean, unscrew filter cap, remove the screen and rinse thoroughly with water. Then, replace screen.
4. Check that incoming water supply is clean and free of debris. Turn the water source on for at least 15 seconds to remove any possible debris in the water before connecting hose to water inlet.
5. Connect one end of a water supply hose (not included) to the water supply and the other end to the water inlet of the jet machine. Water supply must be a minimum of 20 psi and not to exceed 100 psi. Caution: Water temperature must not exceed 140 degrees or damage to the pump can occur. Use only heavy duty 3/4" hose of

no more than 50 ft. in length. If run without an adequate water supply, the pump will cavitate. Cavitation causes the pump to vibrate, causing damage to the pump. Note: Lack of water supply can lead to seal damage, causing a loss of pressure and will void the warranty to the pump.

6. Maximum temperature from the water source should not exceed 140°F (60°C). Using water hotter than 140°F (60°C) can cause damage to the pump and void the warranty. If jet is being used to clear ice blockages, see instructions on Ice Blockages.
7. Select the proper hose diameter for the line to be cleaned. When using new hose, run water through it to clean it out before attaching the nozzle.

OPERATION



NEVER POINT THE END OF THE JET HOSE AT A PERSON WHILE OPERATING.

1. Select the correct jet hose size to match the line size you are clearing. (See Hose Section Guide) Check all hoses for wear and damage. Tighten all connections securely.
2. Select the correct nozzle and attach to the end of the hose. (See Nozzle Selection Guide) Note: If you are using a new jet hose, run water through it to flush out debris before connecting a nozzle.
3. Insert the jet hose 2 to 3 feet into the drain line before turning on machine.
4. Turn on the water supply valve fully to allow for maximum flow.
5. Turn on the jet output valve and allow water to run through the supply hose, jet, and jet hose to purge air from system before turning on the machine.
6. Make sure that the output valve is turned on and the water is flowing.
7. Plug in GFCI power cord to proper receptacle and voltage.
8. While holding onto hose firmly to prevent hose from whipping around, turn the jet motor switch on.
9. Guide the jet hose into the drain line. Do not feed the hose continuously, but rather, move the hose forward and back to allow the pressure to break up the stoppage and the water flow to flush it away. If you are clearing the line from the upstream side, this may take more time. Clearing the line from the downstream side allows debris to flow away easily.
10. It is often helpful to turn on the Vibra-pulse valve. The vibration generated helps to hose overcome the friction in the line and glide farther down the line. See Vibra-pulse section.
11. When the jet hose encounters a bend, it's advance will usually slow or stop. The hose has a slight bend in it from the hose reel. It may be necessary to manually feed or rotate the jet hose to work it around the bends. If the hose won't advance, put the hose in a loop and rotate it a quarter to half turn so the curve of the hose matches the pipe. It may also be necessary to pull the hose back six inches and snap it forward to hop across a gap in the pipe fitting.
12. Once you reach the stoppage, pass the hose back and forth through the section several times to ensure the line is thoroughly cleared. You may also switch nozzles to a wide spray or rotary (optional) nozzle for wall to wall cleaning action.

VIBRA-PULSE®

Pulsation makes the hose vibrate, helping the jet go longer distances and around tight bends easier. The pulse control valve is located on the front of the pump. Simply turn the valve on to engage the pulse. Vibra-pulse is most effective in a 1/8" hose. You'll notice less vibration with a 1/4" hose, and almost none with a 3/8" hose. However, the pulse is still effective, causing the water to burst from the nozzle hundreds of times per second. If you are still having difficulty getting hose around a tight bend, switch to a smaller diameter hose.

SHUT DOWN INSTRUCTIONS

After drain cleaning or spray washing is completed, run clear water through the system. Always leave the output valve in the on position when turning off motor. Turn off water supply and drain as much water from the pump as possible. Remove water supply hose from inlet. If you are in a cold climate, see Freeze Protection section.

SPECIAL APPLICATIONS

ICE BLOCKAGES

High pressure water can be used to clear an ice blockage. A 3000 psi gas jet can clear a 4" line at an approximate rate of one foot per minute. The smaller, electric jet will take twice as long. Ambient air temperature will effect these times. Use a 15° nozzle with a forward jet. DO NOT allow the incoming water supply to exceed 140°F (60°C) or it could cause damage to the pump. Remember to follow the cold weather precautions found in the Freeze Protection section.

FREEZE PROTECTION

To protect your machine from severe damage caused by water freezing inside the components, it is important to winterize it whenever it is subjected to freezing temperatures.

The best way to protect the system is to keep it out of the cold. Barring that, the next best way is to flush the system with anti-freeze. To do so, simply attach a short garden hose (not to exceed four feet) to inlet on the pump and put other end into the anti-freeze container. Be sure to remove the nozzle from the hose. Turn the machine on to draw anti-freeze into the system. When anti-freeze flows out of the end of the hose, turn the machine off. Connect high pressure hose and trigger, and follow above procedure. Cycle trigger on/off so that the anti-freeze will flow into unloader and injector section of machine.

When preparing to operate equipment for the next job, remove the anti-freeze. To do so, reconnect water source, turn pump on and direct flow of anti-freeze back into container. Be careful not to dilute anti-freeze with incoming water supply. Anti-freeze, if kept relatively undiluted, can be used again and again.

Hoses can also be protected from freezing by using compressed air to clear them of residual water. Remember to remove nozzle from jet hose and hold trigger of spray wand in open position.

ADJUSTING PRESSURE UNLOADER

The machine is equipped with a regulating pressure unloader to prevent pressure overload in the event that the nozzle is clogged or the output valve or spray wand trigger is off. When the machine is in the bypass mode, the pump will continue to run. However, running in bypass mode for extended periods will cause damage to the pump - no more than 5 minutes with the J-1450 pump. Excessive temperatures will damage the pump and void the warranty.